



W O O D F O R D
S T O V E S

STOVE MANUAL

Lowry 5
Lowry 5X
Lowry 5XL

**REGISTER MY
FREE WARRANTY**



PLEASE RETAIN THIS GUIDE FOR FUTURE REFERENCE

Contents

Lowry Stove Collection.....	4
1. Identifying your stove.....	5
1.1 Identifying parts & terminology of your stove-External.....	5
1.2 Identifying parts & terminology of your stove-Internal.....	6
2. Warnings.....	7
2.1 Important Warnings.....	7
3. Health & Safety.....	7
3.1 Health & Safety Practice.....	7
4. Installation Requirements.....	8
4.1 Hearths and Recesses.....	8
4.2 Combustible Materials.....	8
4.3 Air For Combustion.....	9
5. Flue And Chimneys.....	9
5.1 Requirements.....	9
6. Installing The Stove.....	11
6.1 Unpacking Your Stove.....	11
6.2 Connecting The Spigot Outlet to The Flue System.....	13
6.3 Firebox Liner Panels.....	13
6.4 Optional Accessories.....	13
6.5 Smoke Control Area (The Clean Air Act 1993 & Smoke Control Areas).....	13
7. Commissioning the stove.....	14
7.1 Checklist.....	14
8. Warnings.....	15
8.1 Important Warnings.....	15
8.2 Health and Safety.....	16
8.3 Smoke control areas (The Clean Air Act 1993 & Smoke Control Areas).....	16
9. Recommended fuels.....	17
9.1 Wood.....	17
9.2 Solid Fuel.....	17
10. Before using your stove.....	18
10.1 Pointers Before Use.....	18
11. Air inlet controls.....	19
11.1 Air Inlet.....	19
11.1.1 Primary air control.....	19
11.1.2 Secondary air control.....	20
11.1.3 Tertiary air control.....	21
12. Lighting your stove.....	21
12.1.1 Smoke control areas.....	21
12.1.2 Fuel overloading.....	21
12.1.3 Operation with door left open.....	21
12.1.4 Dampers / Air controls left open.....	22
12.2 Burning wood.....	22
12.3 Burning solid fuels.....	22
12.4 Warning-Fume/Smoke emissions.....	23
12.5 Refueling on to a low fire bed.....	24
12.6 Smoke Control Area (The Clean Air Act 1993 & Smoke Control Areas).....	24
12.7 Typical burn for nominal output.....	24
13. Further information for all stove owners.....	25
13.1 Reduced burning (Slow Combustion).....	25
13.2 Over firing.....	25
13.3 Chimney fires.....	25

13.4	Periods of non-use (summer months)	25
13.5	Multi Fuel Kit Optional Accessories	26
13.5.1	Riddling the firebox	26
13.5.2	Ash removal	26
13.6	Replacement parts	27
13.7	Classification	27
13.8	Adverse weather conditions	27
13.9	Door glass	27
13.10	Fire door handle	27
14.	Care for your stove	28
14.1	Adjusting the door hinges	28
14.2	Liners / firebricks	28
14.3	Throat plate	28
14.4	Fire door seal	28
14.5	Cracked glass	29
14.6	Chimney/Flue Sweeping	29
15.	Further resources/information	29
15.1	Information	29
15.2	Specification	29
16.	Guarantee	30
16.1	Guarantee	30
16.2	Terms and Conditions	30
16.3	General	31
17.	Technical specification	32
	The Lowry	32
	The Lowry 5X	33
	The Lowry 5XL	34

Lowry Stove Collection

Congratulations on the purchase of your new stove!

More than 30 years of experience has been put into the development of your stove to ensure ultimate performance and years of trouble-free use and enjoyment. Every detail of your stove has been carefully designed and engineered which is why we are so confident in the reliability of our products.

Your stove is built to the highest standard of craftsmanship using the best materials and the most modern equipment available. It is a highly efficient and sophisticated piece of machinery and when professionally installed and operated it should provide a lifetime of heating satisfaction.

Should you have any questions about your stove which are not covered by this manual, please contact your retailer in your area or visit our website: www.flue-ducting.co.uk, which offers a wealth of information on how to care for and get the best from your stove.

Please ensure that you read these instructions in full and understand them before operating your stove.

Flue & Ducting has a policy of continuous product development and therefore we reserve the right to amend specifications without prior notice.

Due to printing cycles, items or options may be described before they are available or after they have ceased. Please check with your retailer or dealer if you are unsure about any aspect of your stove, its installation or correct use.

1. Identifying your stove

1.1 Identifying parts & terminology of your stove-External

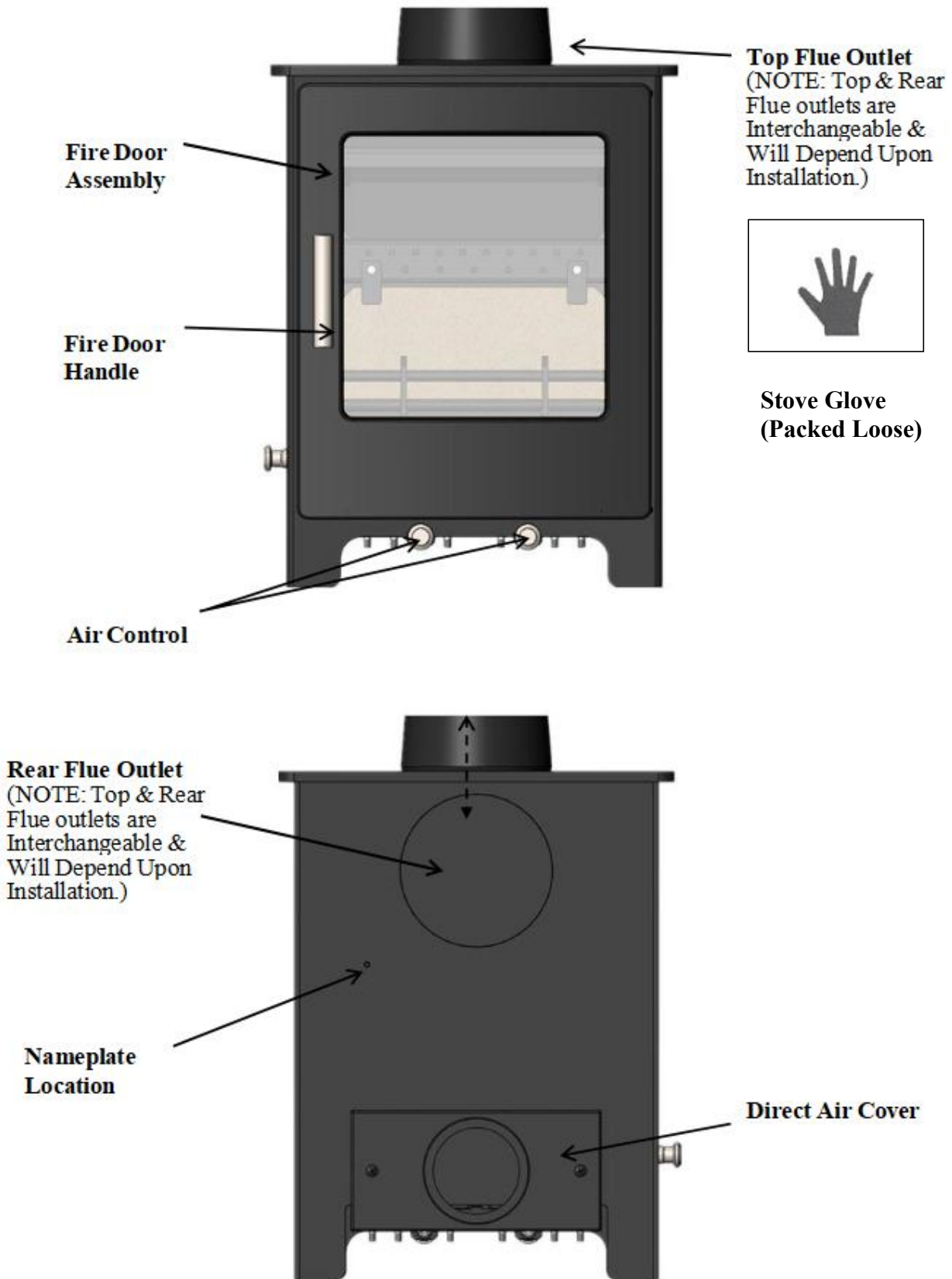

1.2 Identifying parts & terminology of your stove-Internal

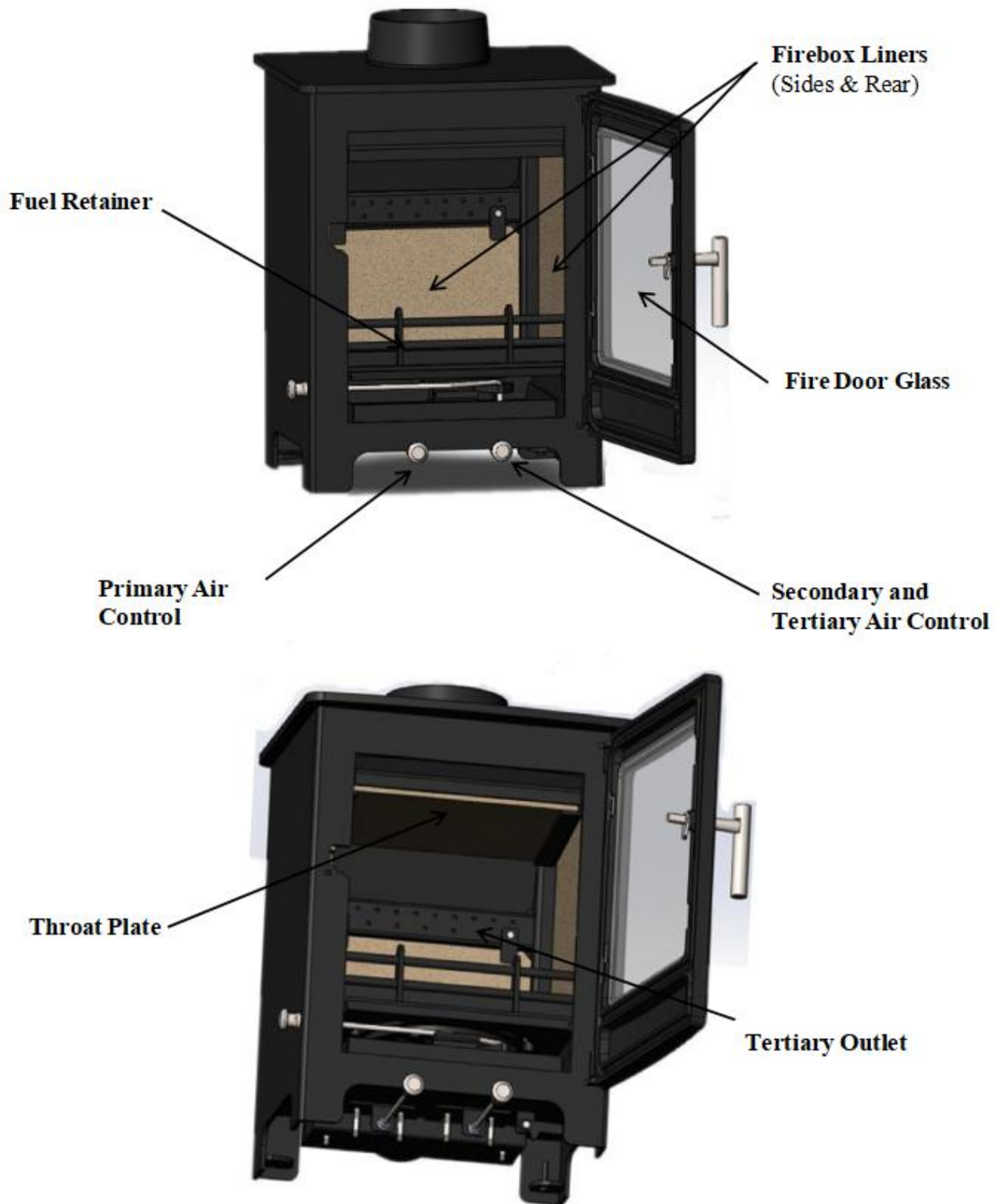

2. Warnings

2.1 Important Warnings

It is a LEGAL REQUIREMENTS that the installation of all new or replacement, wood, or solid fuel heating appliance(s), obtain building control approval, from your local authority or that the installation work must be carried out through a government approved competent person's scheme. A list of all competent person schemes can be found:

<https://www.gov.uk/building-regulations-competent-person-schemes>

All local regulations, including those referring to National & European standards, need to be complied with when installing the appliance.

For the appliance installation, please refer to BS 8303-3:1994 as the code of practice for installation of domestic heating and cooking appliances burning solid mineral fuel.

This stove should not be installed into a chimney or flue system that serves other heating appliances.

The manufacturer's instructions must not be taken as overriding statutory requirements.

Any form of an extraction fan must not be fitted into the same room as the appliance.

Flue & Ducting Ltd will not be responsible for any consequential or incidental loss or injury however caused.

Any further warnings in this document will be marked out in a box such as this one.
Ignoring the warnings, could lead to damage / injury to persons and / or property.

3. Health & Safety

3.1 Health & Safety Practice

Before any installation work is undertaken consideration must be given to the Health and Safety at work Act 1974. Safe working practices should be always followed.

Please consult health and safety guidelines for advice on handling heavy and / or large items.

During installation ensure that adequate precautions are taken to avoid unnecessary risk to yourself or any householder.

The danger from the caustic nature of fire cement, should be avoided by using these accepted methods: Wear gloves when handling fire cement. Wear goggles when chiseling or looking up chimneys.

This stove contains no asbestos. Any possibility of disturbing asbestos during the installation then always seek specialist guidance and use appropriate protective equipment for its removal.

4. Installation Requirements

4.1 Hearths and Recesses

The stove should be installed on a surface with adequate load bearing capacity.

If the existing construction does not meet this prerequisite, suitable measures (e.g., load distributing plate) should be taken to achieve it. Please pay particular attention when examining existing building work for suitability to meet the following requirements.

When installing a stove, hearths should have a sufficiently flat surface to allow a firm seating surface for the stove body to be positioned during its installation. Stonework, uneven bricks, loose tiles etc., may need further work to ensure that this can be achieved.

Your stove must always be placed on a non-combustible material such as granite, slate, steel or glass. Always check the size of your stove before buying a hearth. If the heat from the stove doesn't raise the temperature of the hearth above 100°C, the following measurements must be met:

- The hearth must extend at least 300mm to the front and 150mm to either side;
- The full area of the hearth should be at least 840x840mm;
- It must be at least 12mm thick.

If required, the dimensions of any constructional hearth for Lowry should project at least 600 mm forward of the front of the appliance and 500 mm at the sides. For Lowry 5X should project at least 600 mm forward at the sides. For Lowry 5XL should be project at least 800mm forward of the front of the appliance and 400 mm at the sides. The surface of the hearth should be free of combustible materials.

In most buildings with solid concrete or stone floors, the requirement will be met by the floor itself, but mark the hearth to ensure floor coverings are kept away or use different levels to mark the hearth perimeter.

Please be aware that hot air can cause staining above the fire in a similar fashion to walls above radiators.

To help prevent this and cracking we recommend that any plaster above the fire should be fitted with reinforcing expanding mesh for at least 220mm above, and the full width of the fire. You should also use a suitably heat resistant plaster which should be allowed sufficient time to fully dry before using the stove or cracking is likely to occur.

4.2 Combustible Materials

Please view the product sheet or data plate which accompanied your stove for specific minimum distances to combustible measurements.

Ideally, adjacent walls should be of suitable non-combustible construction, preferably brickwork.

In large fireplaces take care that any supporting beam is protected by a 13mm sheet of heat resistant fire board spaced 12mm off the surface with strips of non-combustible material. Make sure that there is a gap between an un-insulated flue system and any combustible material. This gap must be at least 3X the outside diameter of the flue pipe, or 1.5X the flue diameter to non-combustible surfaces.

Please consult the flue manufacturers specification for insulated flues.

4.3 Air For Combustion

All stoves require ventilation to burn safely and correctly. There are a number of requirements that need to be met when installing a stove, for example, allowing for the permeability of the house (air permeability is the general seepage of air into the house via air vents, doors, and windows etc.)

There must always be a permanent means of providing air for combustion into the room in which the stove is installed. Air starvation will result in poor flue draw and may cause smoke to leak into the room.

Note: If the appliance is fitted with a draught stabilizer (or if one is fitted to the flue pipe or chimney in the same room as the appliance) then the permanent air entry opening (or openings) should be increased by 300mm² for each kW of rated output up to 5kW and an additional 850mm² for each kW output over 5kW.

If there is more than one appliance in the property, then each appliance must be supplied with adequate combustion air so that all appliances can be lit simultaneously.

The positioning of any air vent must be so that it cannot be liable to blockage or obstruction. Ideally it should also be positioned where it is unlikely to cause a cold draught. It should not be positioned in the fireplace recess.

For more detailed guidelines on required ventilation sizes please refer to the Document J Building Regulations (Combustion Appliances) at the www.planningportal.gov.uk website.

5. Flue And Chimneys

5.1 Requirements

The stove must be connected to a suitable and efficient flue so that products of combustion (fumes) from the stove are expelled to the outside air. Please remember that chimney draught is dependent on four main factors:

- Flue gas temperature
- Flue height
- Flue size
- Flue terminal

To ensure a good updraught it is important that the flue gases are kept warm, and that the flue size suits the stove. The termination of the outlet at the top of the flue also needs to comply with Building Regulations. The minimum effective height of the flue must be at least 4.5 meters from the top of the stove to the top of the flue outlet. When warm the flue draught should be between 0.1 to 0.2mb.

The draw of a chimney / flue can vary in different weather conditions and the customer should be made aware of this. Failure to correct an over-drawing flue will invalidate the warranty.

A chimney may comply with regulations but could still be subject to draught and similar problems. A chimney terminating above the ridge level is less likely to suffer such problems. If a new chimney is being provided it should fully comply with the relevant Building Regulations that specify the requirements for solid fuel burning installations. Suitable types of chimneys include the following:

- **Masonry Chimney:** Built with clay or concrete liners, or a chimney block system meeting Building Regulations. These types of chimneys should be installed in accordance with the Building Regulations and BS EN15287-1: 2007.
- **Factory Made Insulated Chimney:** Complying with BS 4543: Part 2 (often called Class 1 prefabricated metal chimney). These types of chimneys should be installed in accordance with Building Regulations and BS EN 15287-1: 2007.

Due to the gradual introduction of European Chimney Standards chimneys will be specified according to their performance designation as defined in BS EN 1443 that covers the General Requirements for chimneys. The minimum performance designation required for use with solid fuel burning stoves is T450 N2 S D3.

Ensure that the flue pipe diameter is not less than the diameter of the appliance outlet.

The flue and chimney installation must be carefully checked by a competent person before fitting the stove to ensure it is suitable and will work safely.

If the chimney is old (i.e., Built of brick or stone without a liner) or being opened for reuse, additional checks and smoke testing as described in Appendix E of the Approved Document J 2010 Edition should also be carried out to ensure the flue and chimney are in good operating condition.

Check the existing flue is in good condition with suitable access for collection and removal of debris.

It is also important that suitable flue pipe (recommended at least 600mm in length) complying with the Building Regulations is used to connect the stove to the flue in the chimney. Suitable access should be provided into the flue for regular inspection and sweeping of the flue ways.

The installer should comply with Building Regulations requirements in respect of providing a Notice Plate giving details on the chimney, flue lining, hearth, and fireplace installation.

Chimneys should be as straight as possible. Horizontal runs should be avoided except where the rear outlet of the appliance is used, in which case the horizontal section should not exceed 150mm in length. If necessary, a combination of 45° and 90° bends can be used if the sum of their angles is not greater than 180° in total. IE: four x 45° bends or two x 45° and a 90° bend.

If the stove is working hard but produces very little output to the room it is likely that excess draw is present in the chimney, and that heat is being sucked out of the appliance and up the chimney. If this is the case we recommend the fitting of a draught stabilizer in preference to a flue damper, in the interest of safety and efficiency.

6. Installing The Stove

To make the stove easier and safer to maneuver, we recommend you remove the following parts which can then be refitted when the stove is in its final position:

Liners, Door (To help prevent the glass from breaking), Operating Tool, Ash pan, Throat Plate & Fuel Retainer.

6.1 Unpacking Your Stove

1. Remove the outer packaging.

- Carefully remove the packing straps and lift off the upper crate.
- Remove the plastic bag and take down the stove from the bottom panel.
- **IMPORTANT** - Ensure the plastic bag is disposed of correctly and kept away from children.

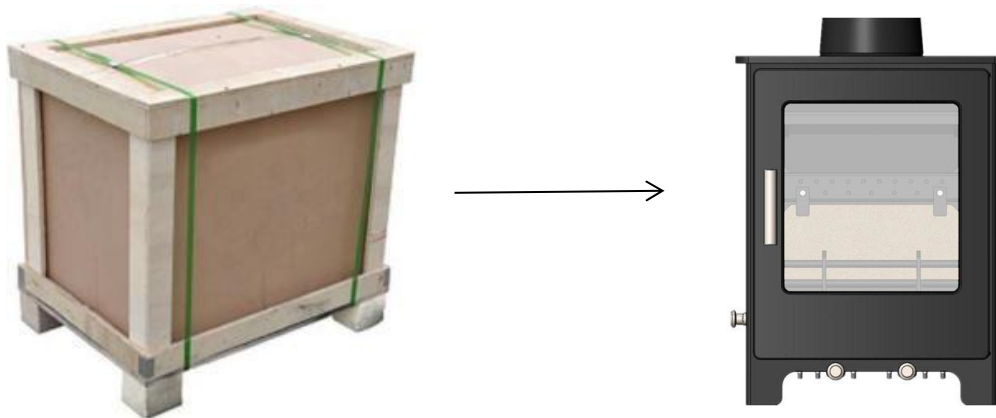

2. Open the door, take out all the contents. Place all the items on a cardboard box or surface that will not scratch or damage the parts.



- 3. Fit the Flue Collar with the set screws and washers supplied Rear or top flue option.
If the Top Flue position is required remove the fitted Flue Cover and refit on the rear opening.**

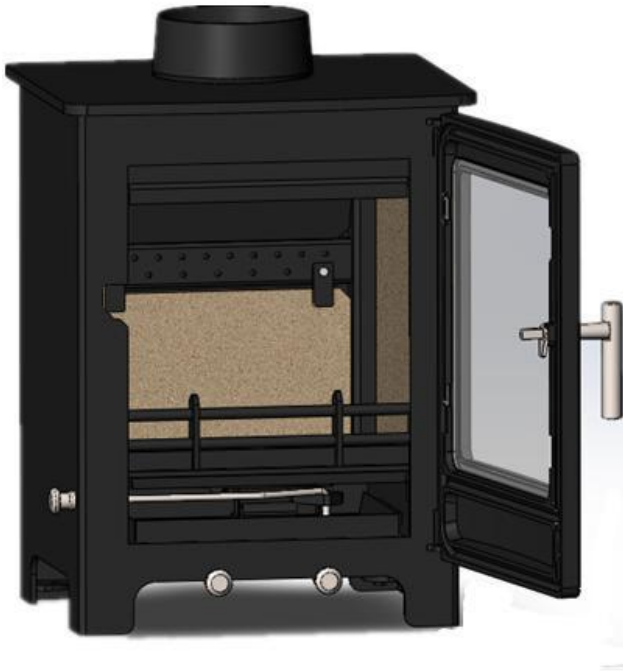

- 4. Fit the retainer bar and ash pan as shown.**
- 5. Fit the back external air inlet with the set screws and gaskets.**

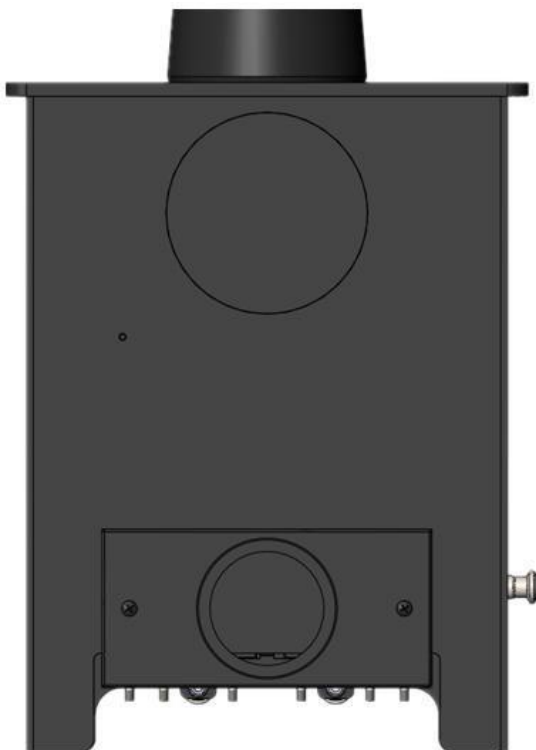



IMPORTANT INFORMATION

When fitting the flue spigot & hot plate, always ensure that the rope seal is fitted. Failure to do so, could lead to exhaust fume leakage into the property and potential carbon monoxide poisoning.

6.2 Connecting The Spigot Outlet to The Flue System

The flue pipe must be fitted inside the outlet spigot as shown in Figure 1. Failure to do so could result in the spillage of condensation running down the flue. Fire cement should be used to create an airtight seal between the flue and spigot.

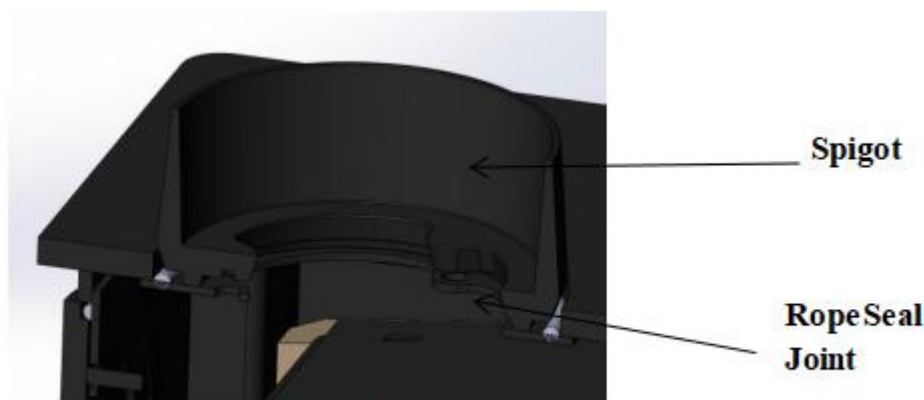

Fig. 1. Flue & Spigot Fitting

6.3 Firebox Liner Panels

All models of the Woodford stove collection, use firebox liner panels to the side, back and either side of the rotating grate to the base of the appliance. The stove will be delivered with the liner panels in situ; however, it may be easier to remove these during installation.

6.4 Optional Accessories

Further optional extras, such as a direct air connector, solid fuel burning kit etc., are available via your retailer or dealer.

6.5 Smoke Control Area (The Clean Air Act 1993 & Smoke Control Areas)

If the stove is to be installed in a designated Smoke Control Area (further information can be found via <https://www.gov.uk/smoke-control-area-rules>) then the secondary air lever must be fitted with a restrictor plate to prevent total closure of the secondary air control. The restrictor plate and additional fixing screw is supplied with your stove.

NOTE:

The minimum air control setting is governed to meet the requirements of Smoke Control exemption and as a result the appliance will NOT shut down completely when in the minimum air position setting.

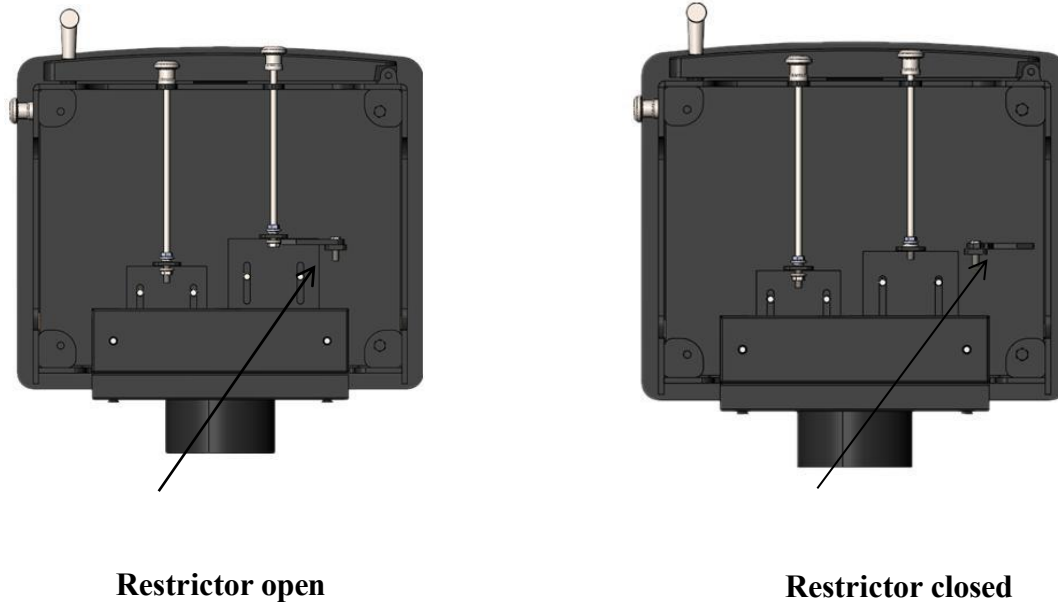

Fig. 2. Smoke Control Restrictor Position



IMPORTANT INFORMATION

Removal or modification of the restrictor is illegal when the appliance is installed in a smoke exemption area and doing so may result in prosecution and fine.

7. Commissioning the stove

7.1 Checklist

Before handing over the installation to the customer it is a requirement under Document J (of the Building Regulations for England and Wales) that the appliance is lit, and the functioning of the chimney system is checked for satisfactory operation.

- Be sure that the chimney is operating, and all smoke and fumes are vented to the atmosphere through the chimney terminal.
- Check all joints and seals.
- Clean the outside of the cold appliance with a lint free cloth or shoe brush to prevent any stains becoming burnt on.
- Check the flue draught which should read 10-20pa, or 0.1-0.2mbar.
- Consult a suitably qualified person who will have the knowledge and equipment to perform a test.

- For a registered Competent Persons scheme (such as those referred to at <https://www.gov.uk/guidance/competent-person-scheme-current-schemes-and-how-schemes-are-authorised>), please complete a Certificate of Compliance, which is used for checking and reporting the installation as imposed by the Government. Otherwise please ensure the installation is approved by your local building control officer.
- Ensure a Carbon Monoxide alarm is fitted. This must be between 1m to 3m from the appliance, and approximately 150mm below the ceiling level.
- A fireguard conforming to BS 8423: 2002 should be used in the presence of children or weakened people.
- A notice plate should be provided containing information on the performance characteristics of the hearth, fireplace, flue, or chimney.
- Explain the following to the customer:
 - How to operate the riddling mechanism and air control lever.

The importance of an adequate air supply to the room.

The importance of regularly having the chimney swept/inspected.

That a protective glove should be used when operating the stove.

How changes in the weather can affect the performance of the stove.

Using the correct fuels.

8. Warnings

8.1 Important Warnings

It is a **LEGAL REQUIREMENTS** that the installation of all new or replacement, wood, or solid fuel heating appliance, obtain building control approval from your local authority or the installation work must be carried out through a government approved competent person's scheme. A list of all competent person schemes can be found here, <https://www.gov.uk/guidance/competent-person-scheme-current-schemes-and-how-schemes-are-authorised>

Any manufacturer's instructions must not be taken as overriding statutory requirements.

All Lowry stoves **MUST NOT** be connected to a shared flue system.

Please Note: Classification of these appliances is for intermittent use only.

Do not use aerosol sprays or any other flammable materials near the appliance when in use.

Do not use the appliance as an incinerator.

Use only recommended fuels, STRICTLY NO unsuitable and non-recommended fuels or materials or liquid fuels allowed.

Pure petroleum coke or Bituminous house coal must NOT be burned in this appliance. The use of these fuels will invalidate the appliance guarantee.

Please ensure that the air inlet vent grills to the dwelling are not obstructed or liable to be blocked.

Caution must be exercised during operation of the appliance as both internal and external surfaces will be hot to touch, use the mitten when the appliance is in operation.

A fireguard conforming to BS 8423: 2002 should be used in the presence of children or elderly people.

Always observe the distances to combustible materials as stated on the appliance data plate and in the technical data section of this manual. Ensure no soft furnishings or combustible materials are susceptible to heat radiating from the appliance.

Under NO circumstances should the stove be operated for extended periods with the main fire door open. This will result in an over firing situation and will lead to severe damage to the stove and flue system.

Ignoring the warnings could lead to damage/injury to persons and/or property.

Flue & Ducting Ltd will not be responsible for any consequential or incidental loss or injury however caused.

It is essential that the appliance has adequate air supply for combustion and ventilation. Apertures provided for this purpose shall not be restricted or covered.

8.2 Health and Safety

Please consult health and safety guidelines for advice on handling heavy and/or large items.

8.3 Smoke control areas (The Clean Air Act 1993 & Smoke Control Areas)

Under the Clean Air Act local authorities may declare the whole or part of the district of the authority to be a smoke control area. It is an offence to emit smoke from a chimney of a building, from a furnace or from any fixed boiler if located in a designated smoke control area. It is also an offence to acquire an "unauthorised fuel" for use within a smoke control area unless it is used in an "exempt" appliance ("exempted "from the controls which apply in the smoke control area).

In England appliances are exempted by publication on a list by the Secretary of State in accordance with changes made to section 20 and 21 of the Clean Air Act 1993 by section 15 of the Deregulation Act 2015. In Scotland appliances are exempted by publication on a list by Scottish Ministers under section 50 of the Regulatory Reform (Scotland) Act 2014.

Similarly in Northern Ireland appliances are exempted by publication on a list by the Department of Agriculture, Environment and Rural Affairs under Section 16 of the Environmental Better Regulation Act (Northern Ireland) 2016. In Wales appliances are exempted by regulations made by Welsh Ministers.

Your local authority is responsible for implementing the Clean Air Act 1993 including designation and supervision of smoke control areas and you can contact them for details of Clean Air Act requirements.

Further information on the requirements of the Clean Air Act can be found here: <https://www.gov.uk/smoke-control-area-rules>

The following list of Lowry stove models:

- Lowry 5 5KW Wood Burning Stove
- Lowry 5X 4.9KW Wood Burning Stove
- Lowry 5XL 4.9KW Wood Burning Stove

The LOWRY multifuel stove has been recommended for use in Smoke Control Areas when burning wood logs. The Lowry 5 stove is fitted with a mechanical stop blocking the combustion air controller at 32mm to prevent closure of the secondary air control beyond 6mm open. The Lowry 5X stove is fitted with a mechanical stop blocking the secondary/tertiary air controller at 50%. The Lowry 5XL stove is fitted with a mechanical stop blocking the secondary/tertiary air controller at 42mm.

9. Recommended fuels

9.1 Wood

As a natural and renewable fuel, wood is the first choice for burning, however burning wood requires a little effort and planning.

Any type of wood is suitable (though hardwood is preferable) provided it is well seasoned and has a moisture content below 20%. This usually implies that the timber has been suitably stored to allow moisture to evaporate for at least 9 months in the case of soft wood, and at least 24 months in the case of hard wood. We recommend that for general burning, wood should be split into logs of no more than 100mm (4inches) diameter.

If, when burning wood, you see signs of sticky tar inside the appliance or chimney, your wood is 'green' or too wet and requires further seasoning. An electronic moisture meter can be obtained to determine the moisture content of your wood fuel. Wet wood must not be used as this will contribute to the creation of tar and creosote which may, in extreme cases, run down the chimney in liquid form. This will seriously damage both the chimney and the appliance and increase the risk of a chimney fire.

9.2 Solid Fuel

Lowry is a multi-fuel and wood burning stove. Flue & Ducting Ltd, recommends the use of approved wood fuels which have been deemed suitable for use on closed appliances including multi fuel stoves or boilers. Authorised fuels suitable for Smoke Control Areas, please see; <https://www.gov.uk/guidance/selling-fuel-in-smoke-control-areas>

For additional advice on fuels, please refer to the Solid Fuel Association (www.solidfuel.co.uk)

DO NOT BURN Bituminous house coal or petroleum coke in this appliance.

PLEASE NOTE: All test data, outputs and efficiencies stated in this instruction manual were obtained by burning 'Maxibrite' mineral smokeless fuel.

DO NOT BURN Any form of plastics in this appliance.

10. Before using your stove

10.1 Pointers Before Use

Lowry wood burning stoves are designed to be operated with the fire door (s) always closed, apart from refueling (when alight) or cleaning (when cold).

Never leave the appliance unattended for an extended length of time with the door(s) open.

Prior to lighting the stove for the first time, please check with the installer that:

- Installation and all building work is complete. (Refer to the installation guide.)
- The chimney is sound, has been swept and is free from obstruction.
- Building Regulations and any local by-laws have been followed during installation.
- All firebox liner panels, and throat plate are in place.
- The chimney draw has been checked and is within specification (between 0.1mb to 0.2mb, or 10-20 pascals). This ensures your stove will operate predictably and efficiently.
- Carbon Monoxide detector is correctly installed in the same room as the appliance.
- Suitable provision for combustion and ventilation air, depending upon building regulations have been undertaken by the installation fitter.
- Consideration must be given for the need for extra ventilation if another heating source needing air is to be operated simultaneously. If an extraction fan is pro-posed to be fitted to a connecting area of the house, after the stove has been installed, professional advice should be sought from a qualified engineer.

Ensure that you have read and understood these instructions before lighting the fire.

Always wear suitable protective fire gloves when refueling your stove, such as the hot glove supplied with your stove. Always keep the hot glove away from naked flames and sparks, when refueling the appliance.

We recommend that you light a small fire for the first few days of use to cure the paint and allow the castings to relax.

You may hear your stove produce clicking or ticking noises whilst it heats up or cools down. This is completely normal and is produced by the expansion and contraction of the steel components in your stove when its temperature changes.

11. Air inlet controls

11.1 Air Inlet

Your stove requires air to function, this enters at the bottom rear of the appliance.

Depending upon installation, an optional direct air kit can be purchased as the connection point for the direct air feed/ducting, installation requirements.

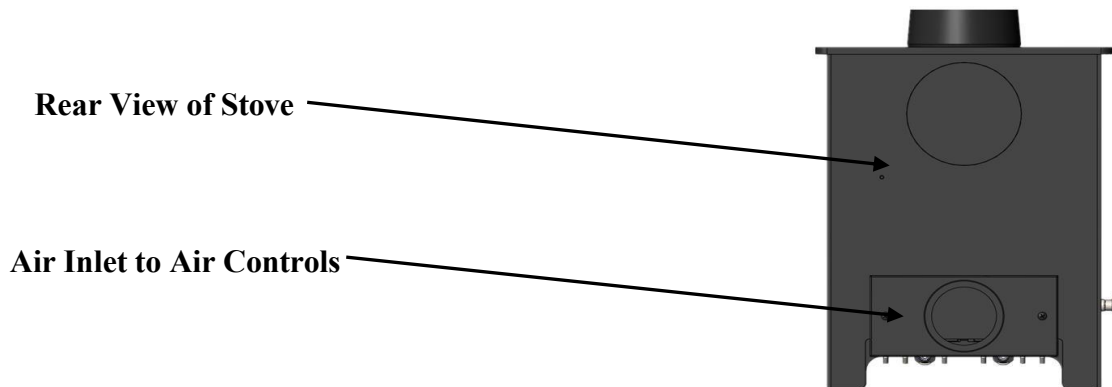

NOTE: DO NOT COVER OR PARTIALLY OBSTRUCT THE AIR INLET OPENINGS FOR THE APPLIANCE.

11.1.1 Primary air control

The primary air control regulates the air entering the fire box chamber, supplying air below the grate. This control is situated below the fire door on the left-hand side, when facing the front of the stove. The control has an internal rotary plate with slots, housed inside the body of the appliance and is located below the left-hand corner of the fire door assembly. Sliding the control knob to the out, as far as it will go, achieves the fully open position, see figure 3. Sliding it to the inside will shut down / reduce the air as shown in figure 4.

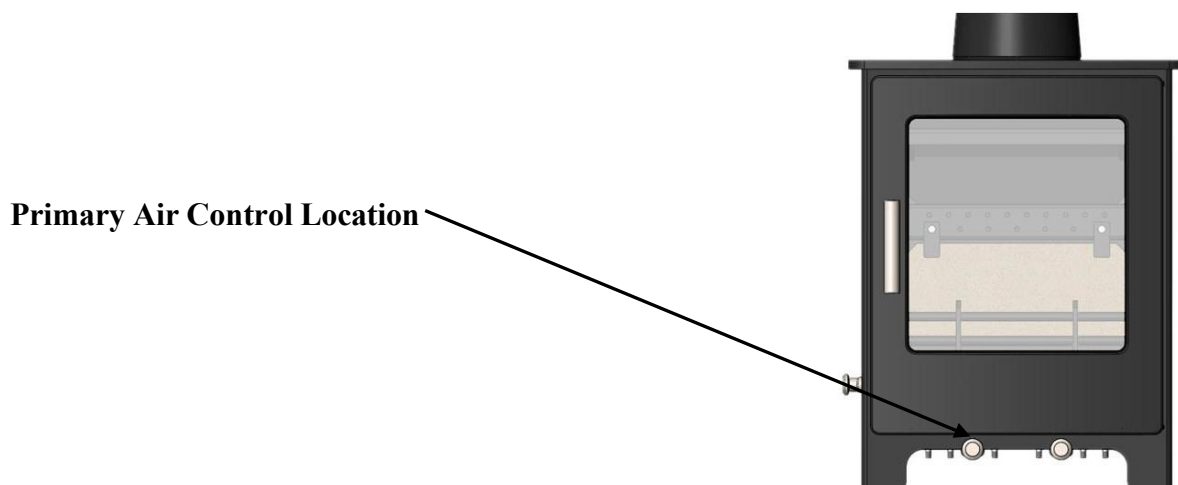

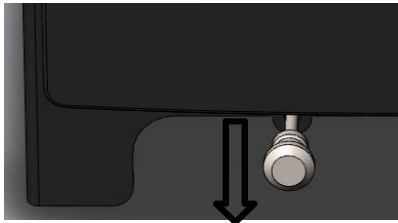

Fig. 3. Fully Open Position

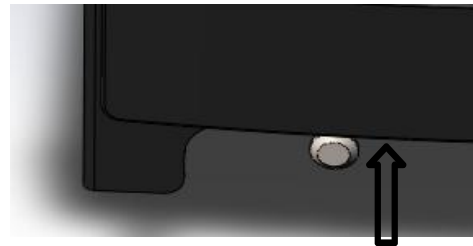
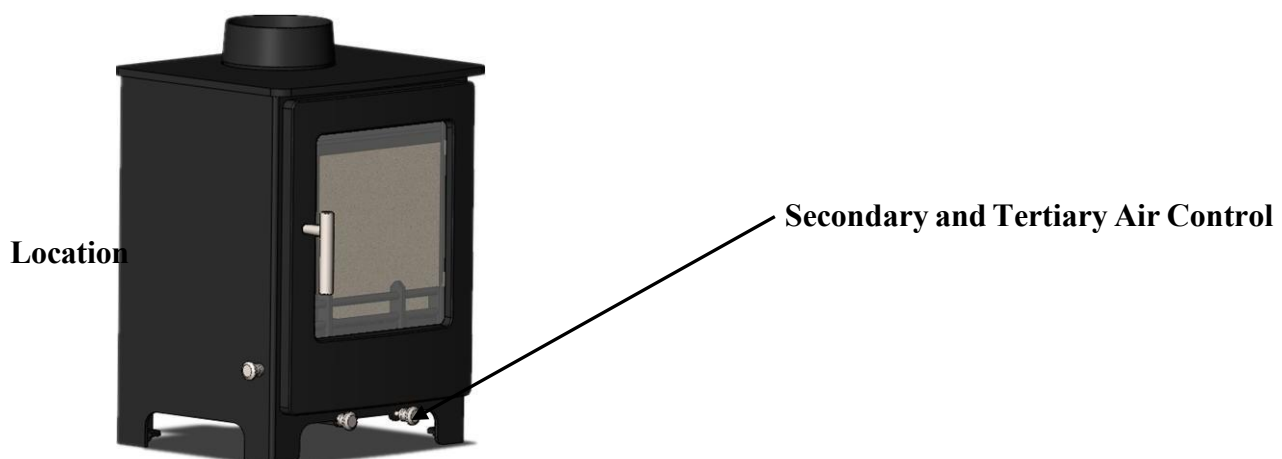

Fig. 4. Fully Closed Position

11.1.2 Secondary air control

The secondary air control regulates the air entering the fire box chamber, supplying an over draught of air to the fuel bed, together with supplying air in front of the glass viewing panel within the door assembly. This is known also as the air wash system.

This control is situated below the fire door on the right-hand side, when facing the front of the stove.



The control has an internal rotary plate with slots, housed inside the body of the appliance and is located below the right-hand corner of the fire door assembly, when looking at the front of the appliance.

Sliding the control knob to the out, as far as it will go, achieves the fully open position, see figure 5. Sliding it to the inside will shut down/ reduce the air as shown in figure 6.

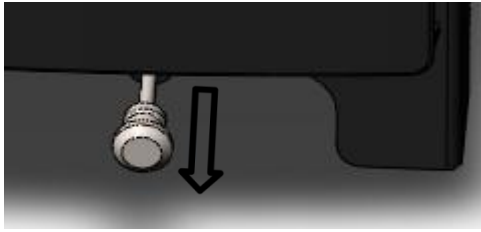

Fig. 5. Fully Open Position

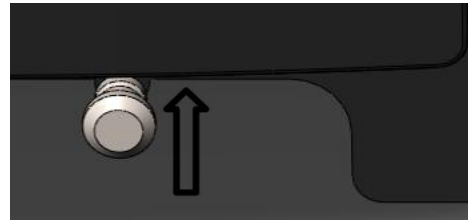

Fig. 6. Closed/Reduced Position



NOTE: If your stove installation is within a smoke control area, it will be fitted with a restrictor plate acting as a mechanical stop for the secondary air control. This will not fully close, thus allowing a bleed of air to the fire box to reduce smoke emissions.

11.1.3 Tertiary air control

All models have tertiary air supply that can be seen working during certain conditions during the burning period. The outlet for the tertiary air, is at the rear of the fire box chamber, just below the throat plate through a series of small holes within the rear liner brick (See page 6).

Tertiary air is employed, to provide additional air to the upper areas of the fire box to promote additional burning of the unburnt combustion gases and thus ensuring a cleaner burn emission.

There is no user adjustment required for the tertiary air, as the required air supply is factory set during the production process.

12. Lighting your stove

12.1.1 Smoke control areas

Please check whether your dwelling is in a smoke control area before installation or use. Please check with your local authority or <https://www.gov.uk/smoke-control-area-rules>.

12.1.2 Fuel overloading

The maximum amount of fuel specified in this manual should not be exceeded, overloading can cause excess smoke. Please see technical data section in this manual.

12.1.3 Operation with door left open

Operation with the door open can cause excess smoke. The appliance **MUST NOT** be operated with the appliance door left open except as directed in the instructions.

12.1.4 Dampers / Air controls left open

Operation with the air controls or appliance dampers open can cause excess smoke. The appliance must not be operated with the air controls, appliance damper or door (s) left open except as directed in these instructions.

12.2 Burning wood

When wood is burnt, it is in fact the volatile gases released from the wood, that burn, and this requires a good supply of air coming from above the fuel. For this reason, we will use all the air inlets while igniting the stove but will then reduce this to air coming from the air wash system and over draught. As much as 40% of the heat from burning wood is obtained from secondary combustion and this can be severely hampered by air entering the fire box from below the fuel.

1) Set the fire, by placing several layers of dry kindling wood into a crisscross grid pattern on top of the grate bars. The use of two or three firelighters may assist in lighting the kindling.

2) Fully open the primary and secondary air controls and light the firelighters and or kindling wood.

3) After the kindling has caught light, you should almost close the fire door leaving it ajar by about 10mm. This will aid flue draw during the initial lighting of the fire.

4) The flue temperature and draw should be established after five minutes, and the kindling reduced to form an ember bed. Carefully load the stove with well-seasoned wood and fully close the fire door.

5) After ten minutes, fully close the primary air control and regulate the secondary air control to control the burn rate and maintain clear glass, typically by reducing to half open.

12.3 Burning solid fuels

Solid fuel burns best with its air supply for combustion coming from underneath the fuel. To achieve this, the burn will be controlled by the primary air control.

A reduced setting may also be required on the secondary air control, to maintain clear glass on the door assembly.

Riddling the stove occasionally will also help to ensure that burnt fuel does not prevent the supply of air from reaching the fuel bed.

The procedure for lighting/burning solid fuel, is as follows:

- 1) Set the air wash (secondary) air control to about one quarter open and the primary air control fully open.
- 2) Lay the fire by using several layers of dry kindling wood into a crisscross grid pattern on top of the grate bars. The use of two or three firelighters may assist in lighting the kindling.
- 3) After the kindling has caught light, you should almost close the fire door leaving it ajar by about 10mm. This will aid the flue draw during the initial lighting of the appliance.
- 4) Once the flue draw has been established, after about five minutes, carefully load the stove with solid fuel, it is suggested that the initial loading is best done using fire tongs and placing the fuel, rather than shoveling the fuel.
- 5) When the fire is well alight regulate the burning rate by controlling the primary air control.
- 6) The secondary air control (air wash) should be closed enough to enable a sufficient supply of air to the glass to keep the door glass clean.
- 7) Whilst burning solid fuel it can be beneficial to occasionally riddle the grate bars so any burnt fuel will fall between the grate bars into the ash pan. Please see 'Section13-Further Information on the procedure for riddling.

12.4 Warning-Fume/Smoke emissions

Professionally installed, with a suitable flue or chimney, operated and maintained correctly, this appliance will not emit fumes into the dwelling. Occasional fumes when removing the ash and refueling may occur.

However, persistent fume emission is potentially dangerous and must be investigated by an approved/registered installer.



STOP USING THE APPLIANCE IF YOU SMELL FUMES OR SEE SMOKE ESCAPING.

If fume emission does persist, the following immediate actions should be taken:

- Open doors and windows to ventilate room.
- Let the fire die or extinguish and safely dispose of fuel from the appliance.
- Check for flue or chimney blockage, and clean if required.

Seek expert advice from your approved installer.

Do not attempt to re-light the fire until the cause of the fume emission has been identified and corrected.

12.5 Refueling on to a low fire bed

If there is insufficient burning material in the fire bed to light a new fuel charge, excessive smoke emission can occur. Refueling must be conducted onto enough glowing embers and ash that the new fuel charge will ignite in a reasonable period. If there are too few embers in the fire bed, add suitable kindling for ignition to prevent excessive smoke.

Important notes on usage, to meet the requirements of Smoke Control exemption-

- **Always recharge onto hot embers.**
- **After re-charging, fully open both the primary and secondary air controls for the following times, to establish good combustion.**

Lowry 5 5KW Wood Burning Stove

Lowry 5X 4.9KW Wood Burning Stove

Lowry 5XL 4.9KW Wood Burning Stove

- **Do not leave the appliance unattended until flames are well established.**
- **Periodic burning out of the fuel bed at high output to combust any remaining charcoal.**

12.6 Smoke Control Area (The Clean Air Act 1993 & Smoke Control Areas)

If the stove is to be installed in a designated Smoke Control Area (further information can be found via <https://www.gov.uk/smoke-control-area-rules>) then the installer will have fitted the restrictor plate for the secondary air lever to prevent total closure of this air control.



NOTE:

The minimum air control setting is governed to meet the requirements of Smoke Control exemption and as a result the appliance will NOT shut down completely when in the minimum air position setting.

Removal or modification of the fitted air control plate is illegal when the appliance is installed in a smoke exemption area and doing so may result in prosecution and fine.

12.7 Typical burn for nominal output

To perform the most efficient burn at the nominal rated output please consult the specification table at the rear of this manual. Please note, many factors can affect the nominal output, so the stated weights of fuel (Seasoned hard wood, Beech, and Mineral solid fuel, 'Maxibrite') are a guide, which is a representation to laboratory test burn conditions.

13. Further information for all stove owners

13.1 Reduced burning (Slow Combustion)

When wood is burnt slowly in a closed appliance (e.g.: air controls at the minimum setting), it produces moisture and tar, which will create condensation and deposits in the chimney. This effect can be minimised by burning hard for a short period, fifteen to twenty minutes twice a day.

To avoid chimney problems your appliance should not be burnt at a reduced burn rate without a period of fast burning. Fast burning is when the stove is burnt with a 'lively flame' and a higher temperature. We strongly advise against stoking the fire with wood and reducing the air inlets before leaving the stove to extinguish (perhaps when retiring to bed) as this can lead to a cooling of the stove and flue also resulting in incomplete combustion, sooty deposits and high levels of pollutant gases released into the environment.

13.2 Over firing

DO NOT over fire your appliance. Firing the stove at maximum for prolonged periods may result in over-firing. If the chimney connector or casing glows red the appliance is being over-fired, and this may result in a chimney fire. Other signs include warping, and a red oxide coloring will demonstrate the over- heating of internal parts, body paint which has turned dusty white is also indicative of such use.

13.3 Chimney fires

Used in the correct manner, with the correct fuel and regular maintenance a chimney fire should never occur, however in the event of a chimney fire, the following procedure should be actioned without delay:

- **Call the fire service-DIAL 999**
- **Immediately close all the air inlet supplies on the appliance, to reduce the air supply to the stove.**
- **Move items of furniture and combustibles away from the surrounding area of the stove, to reduce the risk of fire and allow access for the fire service.**
- **Ensure access to the loft space is available.**
- **Evacuate the property.**

13.4 Periods of non-use (summer months)

Please ensure that your stove is left clean and moving components are well lubricated with a water repelling corrosion inhibitor for the summer months (during periods of prolonged non-use). If possible, store the throat plate outside of the stove. Check all moveable components at regular intervals, to ensure they are moving freely. Allow air movement through the stove by opening the primary air inlet control (s) to about halfway, open or leave the door ajar. This will allow a free flow of air through the appliance thus preventing moisture and condensation forming inside the stove and chimney. This preventative maintenance will ensure your stove stays in the best condition for the coming winter months.

13.5 Multi Fuel Kit Optional Accessories

13.5.1 Riddling the firebox

To riddle the grate, the main fire door will need to be open, carefully open the fire door, using the stove glove supplied. Multi Fuel Kit Optional Accessories mounted riddle lever, using the glove, move the lever left to right, repeatedly, until the ember/ash bed has been reduced. Note: if this procedure is performed vigorously then ash discharged from the firebox, care should be taken to avoid this from happening.



Fig. 7. Ash pan and Operating Tool

13.5.2 Ash removal

The ash pan should be emptied when the level of ash reaches the top of the ash pan. On no account should the ash be allowed to build up to touch the underside of the grate, as this will reduce the life span of the grate.

To remove the ash pan **ALWAYS USE** the supplied glove & operating tool.

- Open the door of the stove, pausing briefly when ajar to allow the fire to adjust to the increased air supply.
- Insert the fork end of the operating tool into the ash pan (see Fig. 7.).
- Carefully withdraw the ash pan from the ash pit chamber.
- Empty the ash into a suitable metal container. Replace the ash pan into the stove, reversing the above procedure and close the fire door.



WARNING: Ash can be extremely hot! Care must be taken not to burn hands or house-hold objects with falling embers-ALWAYS USE THE GLOVE SUPPLIED.

Empty only into a metal container. Even if the ash appears cold, red-hot embers may be concealed and could easily start a fire or cause an injury.

13.6 Replacement parts

Genuine replacement spare parts can be obtained from your Flue & Ducting retailer/dealer.

You can find a complete list of spares and consumables such as liners, replacement grate parts and throat plates as well as items to enhance its visual appearance and efficiency such as stove paint and rope kits.

It is worth noting that the fitting of non-official parts to your stove will invalidate its guarantee.

13.7 Classification

All Lowry stoves are classed as intermittent operation. Thereby meaning, to give nominal rated output, you will have to refuel a minimum of 45 min for wood or 1hr for solid fuel, as stated in EN 13240:2001.

13.8 Adverse weather conditions

If due to adverse weather conditions your stove does not operate correctly and causes the stove to emit smoke, do not treat it as a nuisance, this smoke will indicate that carbon monoxide is being emitted into the room. Extinguish the stove by reducing the firing rate, open windows and allow the stoves' fuel to burn out before closing the windows. The probable cause is insufficient draw, check flue ways and have the chimney tested for flue pressure.

13.9 Door glass

The door glass should remain clear during normal burning. However, under certain conditions, such as burning at a low or slow rate, using damp wood or overnight burning, the glass may become blackened. To remedy this, operate the appliance at a fast rate. Alternatively, when the stove is cold, open the door and clean the inside face of the glass with a damp cloth or with glass cleaner.

13.10 Fire door handle



Care must be taken when opening and closing the fire door as any surrounding surfaces will be VERY HOT.

ALWAYS USE THE HOT GLOVES WHEN USING THE FIRE DOOR/RIDDLE HANDLERISK OF PERSONAL INJURY MAY OCCUR.

CAUTION MUST BE GIVEN WHEN RE-FUELING THE APPLIANCE, KEEP THE GLOVE AWAY FROM NAKED FLAMES & SPARKS.

14. Care for your stove

The need for regular maintenance on your stove will ensure, safe and efficient use of your appliance. The following item listing should be checked and inspected by a competent person or engineer on a regular basis.



PLEASE ENSURE THAT THE STOVE IS UNLIT AND COLD, BEFORE ATTEMPTING TO INSPECT THE BELOW ITEMS-

14.1 Adjusting the door hinges

Once the appliance has been under fire for a period the fire door may appear to have moved out of alignment with relation to the door aperture or catch. This is quite normal and due to the settling of the casting. It may be possible to tighten the retaining screws on the hinge assembly.

14.2 Liners / firebricks

The stoves liners (also known as firebricks) may become cracked after long periods of heavy use or after being knocked by the loading of fuel or a poorly aimed fire poker. If the liners are still staying in situ and can support themselves correctly there is no need to replace them. Cracked liners will not in themselves affect the performance of the stove.

14.3 Throat plate

The throat plate can be removed from the stove, by lifting the throat plate up and removing the rear liner, this will then allow the rear of the throat plate to swing down. Disengage the front lip of the throat plate from the upper location bracket. Rotate the throat plate, diagonally across the firebox, manipulating the plate through the door opening.

Any accumulated deposits should be cleaned off, this is best done with a brush. Whilst doing so, inspect the throat plate for any damage. Replacement throat plates can be sourced from your local dealer or via the internet at www.flue-ducting.co.uk

14.4 Fire door seal

The rope seal around the edges of the main fire door should also be checked. Look for signs of fraying, peeling away or the ends not meeting. If the rope is unable to create a good seal with the stove body, it should be replaced. A poor seal will decrease your ability to control the burn rate and its efficiency whilst leading to an increase in heat lost through the flue.

14.5 Cracked glass

It is not recommended to operate the stove with cracked glass, this can lead to over firing due to air leaking into the firebox and it may fail completely leading to personal injury or a fire.

You should discontinue use of your stove until it has been repaired. You can source replacement glass kits from www.flue-ducting.co.uk or your local retailer.

14.6 Chimney/Flue Sweeping

Sweeping should be carried out with an appropriately sized bristle brush and rods to suit chimney size and type. As with all appliances regular sweeping of the flue/chimney is essential to avoid dangers of blockage and the escape of poisonous fumes. Access for cleaning should also be incorporated in the chimney (e.g.: soot door or access through the register plate etc.).

It is important that the flue connections, flue pipe and chimney be cleaned prior to lighting after a prolonged period of non-use.

15. Further resources/information

15.1 Information

- . Competent Person Schemes
<https://www.gov.uk/guidance/competent-person-scheme-current-schemes-and-how-schemes-are-authorised>
- . Document J Building Regulations (Combustion Appliances)
www.planningportal.gov.uk/
- . The National Association of Chimney Sweeps (NACS)
www.nacs.org.uk/
- . Smoke Control Areas-The Rules
www.gov.uk/smoke-control-area-rules

15.2 Specification

All Lowry stoves are manufactured and independently tested to EN standard 13240: 2001. Within the above EN standard, material specifications and criteria are defined.

16. Guarantee

16.1 Guarantee

If any part of the main body of the stove fails due to a manufacturing or material defect during the guarantee period that applies in respect of the relevant stove (as set out below), Flue & Ducting Ltd will, at its sole discretion, repair or replace your stove, for no charge.

For the purposes of this guarantee, a material or manufacturing defect includes the splitting or cracking of the main body (defined as the steel outer casing and items fixed immovably to the casing).

Damage caused by over-firing or over-heating is not covered. Warping and a red oxide coloring will demonstrate the over- heating of internal parts, body paint which has turned dusty white is also indicative of such use.

The following guarantee periods shall apply in respect of the following:

Lowry stoves come with a **LIFETIME** warranty to the main body of the stove.

The external paint finish carries a one-year guarantee only.

This guarantee is subject to the Terms and Conditions set out below.

16.2 Terms and Conditions

The following terms and conditions must be satisfied for your stove to be covered by the guarantee set out above:

1. Your stove must have been purchased from an officially approved dealer.
2. You must be the original purchaser of the stove to make a claim. This guarantee is not valid in relation to any claims made by someone who did not originally purchase the stove from Flue & Ducting Ltd or an approved retailer/dealer.
3. Any claim under this guarantee must be made through the approved dealer where the stove was purchased and accompanied by proof of purchase (e.g., a valid receipt). Stoves not purchased from an approved retailer/dealer will not be covered by this guarantee.
4. Your stove must be installed in the UK for this guarantee to be valid. Stoves installed outside of the UK will not be covered by this guarantee.
5. Your stove must have been installed by a suitably qualified person and in accordance with the manufacturer's installation instructions. Stoves not installed by a suitably qualified person or not

installed in accordance with the manufacturer's installation instructions will not be covered by this guarantee.

6. Any claims under this guarantee shall not be valid where the installation of the stove does not conform to all required building regulations and other legislation in force at the time of purchase and where flue draw readings have not been made to confirm a suitability of the flue. The manufacturer's decision as to whether this condition has been satisfied shall be final.

7. The guarantee does not cover damage caused to the stove through careless handling or misuse or neglect of the appliance (misuse and neglect being not following the manufacturer's instructions and user guides in relation to the stoves, including the use of non-recommended fuels).

8. The following consumable service items are not covered by this guarantee:
Firebox linings • Grate • Fuel retainer • Throat plate • Door/Door glass • Seals

9. The guarantee does not cover damage caused by storing or using the stove in a damp environment, defects or faults caused by local conditions such as draught problems and chimney defects or corrosion caused by condensation, damp or water ingress into the flue, chimney, or the surrounding of the stove.

10. The guarantee is only valid if the stove is serviced and checked annually by a suitably qualified heating engineer, with documentation to be retained and produced in the event of a claim being made.

11. The guarantee is only valid where any spare parts used are supplied by Flue & Ducting or an approved retailer/dealer. The use of spares other than those supplied by Flue & Ducting Limited shall invalidate the guarantee. Parts can be purchased through an approved dealer or directly from Flue & Ducting online at www.flue-ducting.co.uk

12. The guarantee is not valid where any repairs or modifications have been made to the stove which have been carried out by anyone other than Flue & Ducting Ltd or its authorised representatives or approved dealers.

13. All guarantee periods commence on the date of purchase and are non-transferable and solely for the benefit of the original purchaser of the stove.

16.3 General

Our guarantee is offered as an addition to your statutory rights and will not affect your statutory rights. You can obtain information about your legal rights from trading standards office's or a citizens' advice bureau. This guarantee is applicable in the UK only and operates exclusively in accordance with the laws of England and Wales.

If you believe your appliance is not working correctly or it has broken down, in the first instance please contact your local retailer or installer for assistance.

17. Technical specification

The Lowry

Lowry	Wood - Primary Fuel	Smokeless Fuel
Nominal Heat Output	5.0 kW	4.9 kW
Net Efficiency	75.6 %	86.5 %
Seasonal Efficiency	65.6%	76.5%
PM at 13% O ₂	28 mg/m ³	16 mg/m ³
OGC at 13% O ₂	118 mg/m ³	45 mg/m ³
CO at 13% O ₂	1499 mg/m ³	1301 mg/m ³
NoX at 13% O ₂	102 mg/m ³	111 mg/m ³
Mean Flue Gas Temperature	282 °C	210 °C
Flue Gas Mass Flow	5.5 g/s	3.2 g/s
Indirect Heating Functionality	No	No
Type of Heat output room Temperature control	Two or more manual stages, no temperature control	
Other Control Options	N/A	
Energy Index	100	

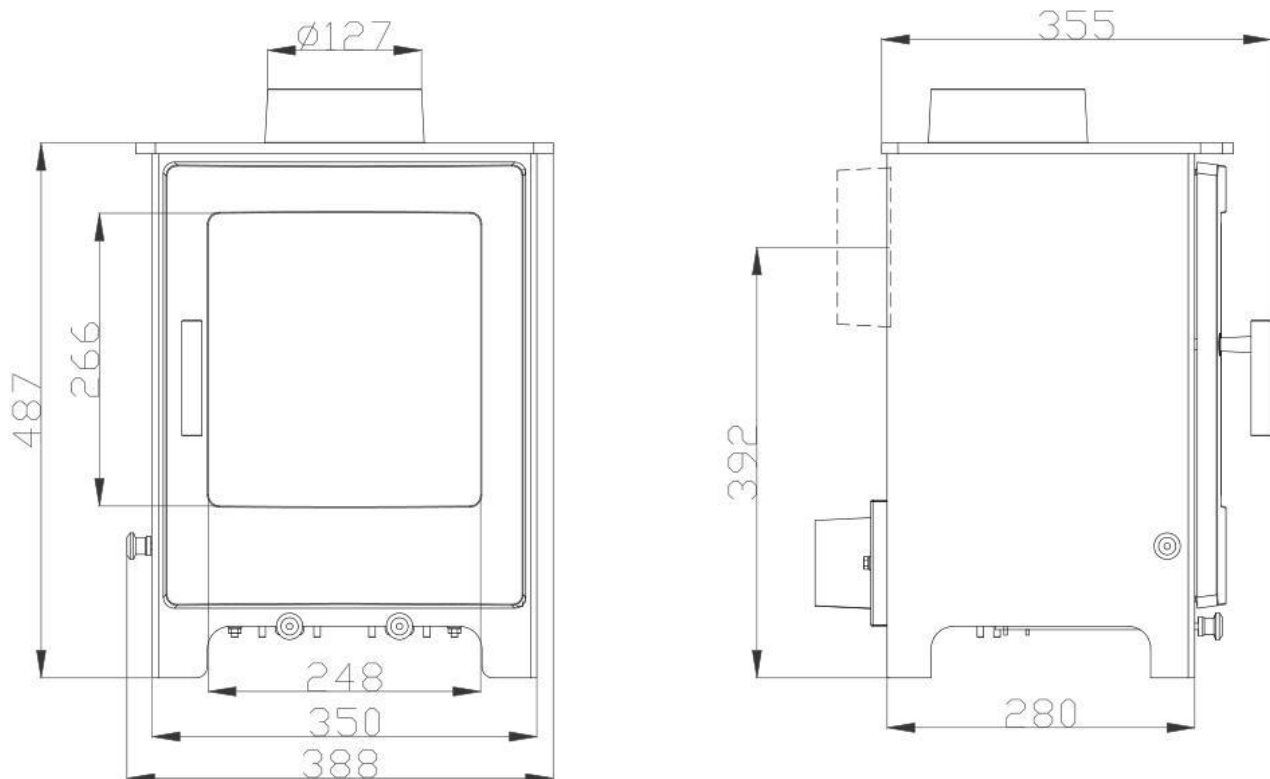

The Lowry 5X

Lowry 5X	Wood - Primary Fuel	Smokeless Fuel
Nominal Heat Output	4.9 kW	4.9 kW
Net Efficiency	83.2 %	86.7 %
Seasonal Efficiency	73.2 %	76.7%
PM at 13% O ₂	21 mg/m ³	12 mg/m ³
OGC at 13% O ₂	80 mg/m ³	71 mg/m ³
CO at 13% O ₂	1372 mg/m ³	1026 mg/m ³
NoX at 13% O ₂	106 mg/m ³	147 mg/m ³
Mean Flue Gas Temperature	196 °C	225 °C
Flue Gas Mass Flow	4.3 g/s	2.9 g/s
Indirect Heating Functionality	No	No
Type of Heat output room Temperature control	Two or more manual stages, no temperature control	
Other Control Options	N/A	
Energy Index	111	

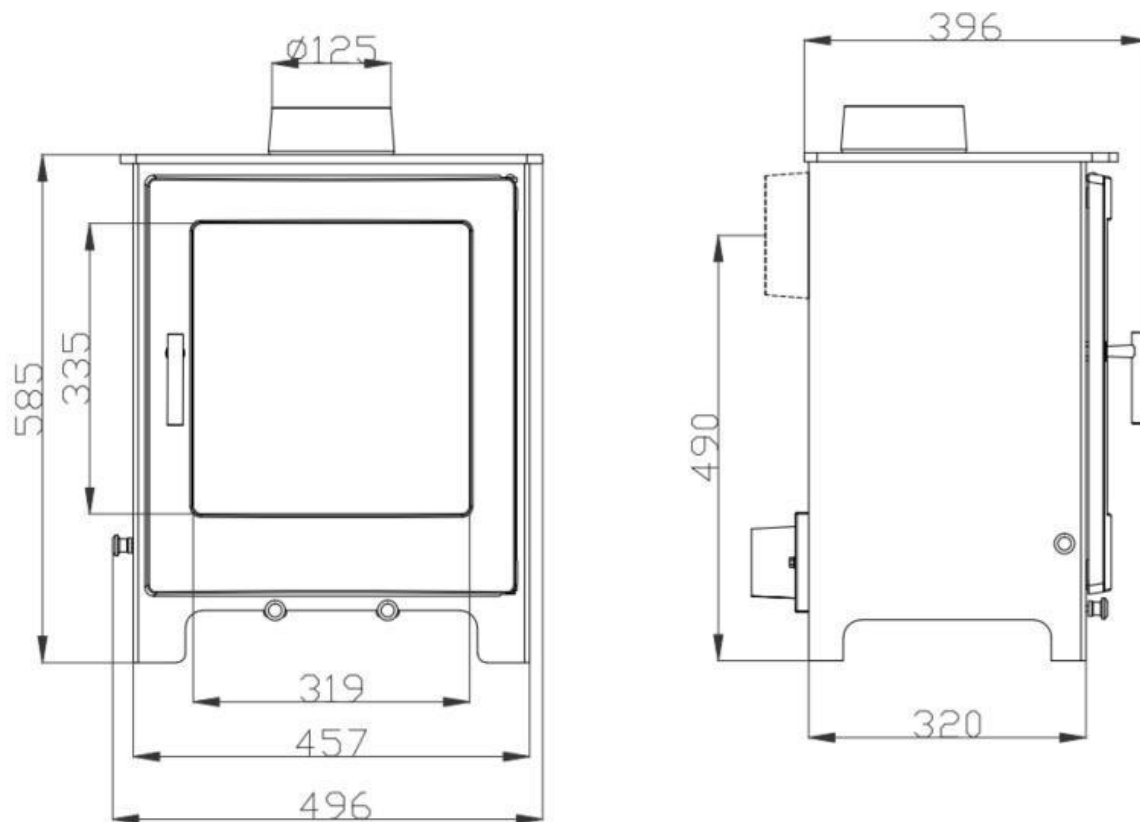

The Lowry 5XL

Lowry 5XL	Wood - Primary Fuel	Smokeless Fuel
Nominal Heat Output	4.9 kW	4.9 kW
Net Efficiency	75.7 %	81.5 %
Seasonal Efficiency	65.7 %	71.5 %
PM at 13% O ₂	29 mg/m ³	21 mg/m ³
OGC at 13% O ₂	108 mg/m ³	59 mg/m ³
CO at 13% O ₂	1370 mg/m ³	1447 mg/m ³
NoX at 13% O ₂	119 mg/m ³	152 mg/m ³
Mean Flue Gas Temperature	235 °C	213 °C
Flue Gas Mass Flow	5.9 g/s	4.7 g/s
Indirect Heating Functionality	No	No
Type of Heat output room Temperature control	Two or more manual stages, no temperature control	
Other Control Options	N/A	
Energy Index	100	

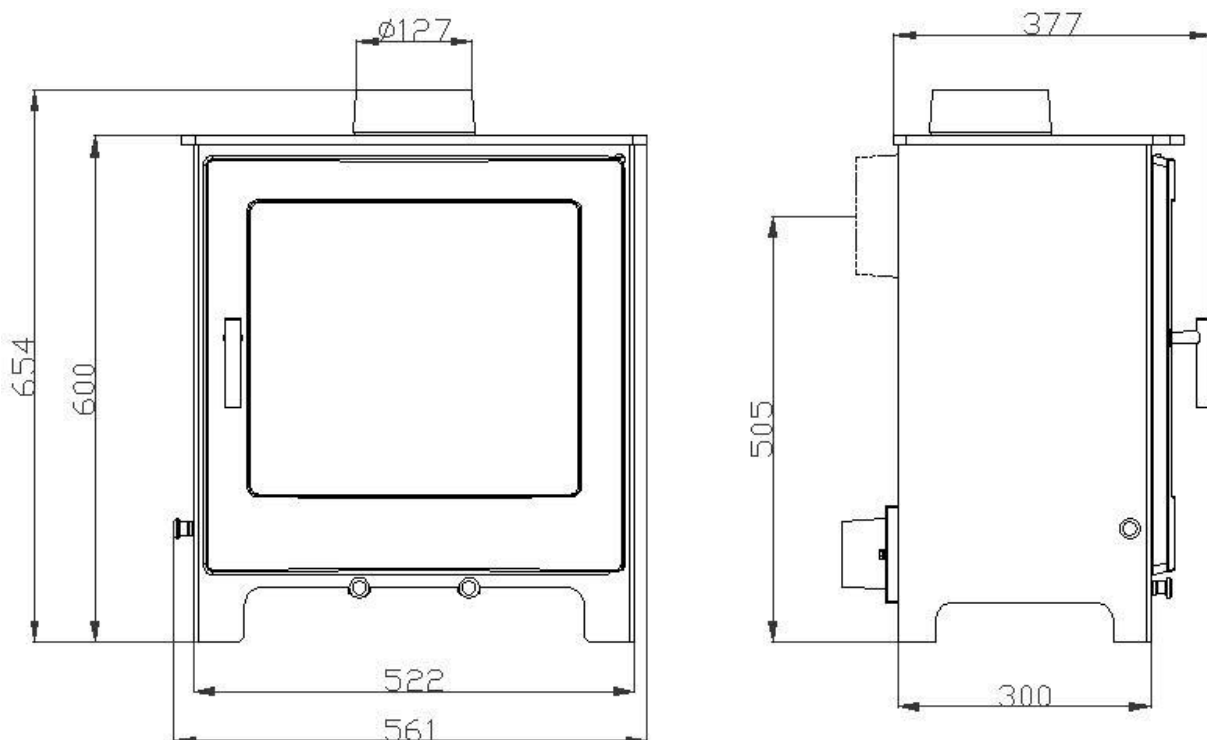

Declaration of performance according to Regulation (EU) 305/2011

Ref No: FL-Lowry-CPR-2020-01

Point	Product Type	Flue & Ducting room heater burning solid fuel without supply of hot water in accordance with EN 13240:2001	
1			
2	Product model designation	Lowry 5, Serial No. -	
3	Intended use	Room heater burning solid fuel without supply of hot water	
4	Manufactured by	Flue & Ducting Unit D6 Yew Street Stockport Trading Estate SK4 2JZ Tel: +44 0161 480 2994 Fax: Email: sales@flue-ducting.co.uk	
5	Manufacturer's authorised representative		
6	System of assessment and verification of constancy of performance	System 3	
7	Notified laboratory name and address	The notified laboratory SGS Nederland B.V., Laboratory number 608 performed the determination of the product type specification on the basis of type testing under system 3 and issued the test report Ref: EZKA/2018-10/000031-3A	
8	Declared performance: -		
	Harmonized Technical specification:	EN 13240:2001	
	Essential characteristics	Performance – Wood	Performance - Ancit
	Fire Safety: - Reaction to fire	A1	
	Clearance distances to combustible materials	Rear = 600mm Sides = 500mm Ceiling = NPD	
	Risk of burning fuel falling out	PASS	
	Emission of combustion products	CO = 0.12%	CO=0.10%
	Surface temperatures	PASS	PASS
	Electrical safety	N/A	N/A
	Cleanability	PASS	PASS
	Maximum operating pressure	N/A	N/A
	Flue gas temperature at nominal heat output	282 °C	210 °C
	Mechanical resistance to carry a chimney	NPD	NPD
	Nominal output	5.0kW	4.9kW
	Room heating output	5.0kW	4.9kW
	Water heating output		
	Gross efficiency	68.8%	84.8%
	Net Efficiency	75.6%	86.5%
9	The performance of the product identified in points 1 and 2 is in conformity with the declared performance given in point 8.		

Signed for and on behalf of the manufacturer by:

(Name)_____
(Date of issue)_____
(Signature)

Declaration of performance according to Regulation (EU) 305/2011

Ref No: FL-Lowry5X-CPR-2021-01

Point	Product Type	Flue & Ducting room heater burning solid fuel without supply of hot water in accordance with EN 13240:2001	
1			
2	Product model designation	Lowry 5X, Serial No. -	
3	Intended use	Room heater burning solid fuel without supply of hot water	
4	Manufactured by	Flue & Ducting Unit D6 Yew Street Stockport Trading Estate SK4 2JZ Tel: +44 0161 480 2994 Fax: Email: sales@flue-ducting.co.uk	
5	Manufacturer's authorised representative		
6	System of assessment and verification of constancy of performance	System 3	
7	Notified laboratory name and address	The notified laboratory SGS Nederland B.V., Laboratory number 608 performed the determination of the product type specification on the basis of type testing under system 3 and issued the test report Ref: EZKA/2019-06/00015-3A	
8	Declared performance: -		
	Harmonized Technical specification:	EN 13240:2001	
	Essential characteristics	Performance – Wood	Performance - Ancit
	Fire Safety: - Reaction to fire	A1	
	Clearance distances to combustible materials	Rear = Non-Combustible Sides = 600mm Ceiling = NPD	
	Risk of burning fuel falling out	PASS	
	Emission of combustion products	CO = 0.11%	CO=0.08%
	Surface temperatures	PASS	PASS
	Electrical safety	N/A	N/A
	Cleanability	PASS	PASS
	Maximum operating pressure	N/A	N/A
	Flue gas temperature at nominal heat output	196 °C	225 °C
	Mechanical resistance to carry a chimney	NPD	NPD
	Nominal output	4.9kW	4.9kW
	Room heating output	4.9kW	4.9kW
	Water heating output		
	Gross efficiency	75.7%	85.0%
	Net Efficiency	83.2%	86.7%
9	The performance of the product identified in points 1 and 2 is in conformity with the declared performance given in point 8.		

Signed for and on behalf of the manufacturer by:

(Name)_____
(Date of issue)_____
(Signature)

Declaration of performance according to Regulation (EU) 305/2011

Ref No: FL-Lowry5XL-CPR-2021-02

Point	Product Type	Flue & Ducting room heater burning solid fuel without supply of hot water in accordance with EN 13240:2001	
1			
2	Product model designation	Lowry 5XL, Serial No. -	
3	Intended use	Room heater burning solid fuel without supply of hot water	
4	Manufactured by	Flue & Ducting Unit D6 Yew Street Stockport Trading Estate SK4 2JZ Tel: +44 0161 480 2994 Fax: Email: sales@flue-ducting.co.uk	
5	Manufacturer's authorised representative		
6	System of assessment and verification of constancy of performance	System 3	
7	Notified laboratory name and address	The notified laboratory SGS Nederland B.V., Laboratory number 608 performed the determination of the product type specification on the basis of type testing under system 3 and issued the test report Ref: EZKA/2019-10/00036-3A	
8	Declared performance: -		
	Harmonized Technical specification:	EN 13240:2001	
	Essential characteristics	Performance – Wood	Performance - Ancit
	Fire Safety: - Reaction to fire	A1	
	Clearance distances to combustible materials	Rear = 800mm Sides = 400mm Ceiling = NPD	
	Risk of burning fuel falling out	PASS	
	Emission of combustion products	CO = 0.11%	CO=0.12%
	Surface temperatures	PASS	PASS
	Electrical safety	N/A	N/A
	Cleanability	PASS	PASS
	Maximum operating pressure	N/A	N/A
	Flue gas temperature at nominal heat output	235 °C	213 °C
	Mechanical resistance to carry a chimney	NPD	NPD
	Nominal output	4.9kW	4.9kW
	Room heating output	4.9kW	4.9kW
	Water heating output		
	Gross efficiency	68.9%	79.9%
	Net Efficiency	75.7%	81.5%
9	The performance of the product identified in points 1 and 2 is in conformity with the declared performance given in point 8.		

Signed for and on behalf of the manufacturer by:

(Name)_____
(Date of issue)_____
(Signature)

DURA FLUE

TOTAL CHIMNEY SOLUTIONS

Flue & Ducting Ltd

Unit D6
Yew Street
Stockport Trading Estate
SK4 2JZ
United Kingdom

